

Apertura verso l'alto per vetri lineari Sistema **020**  
*Lift up opening for linear glasses System **020***

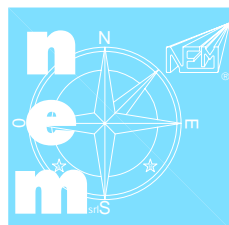

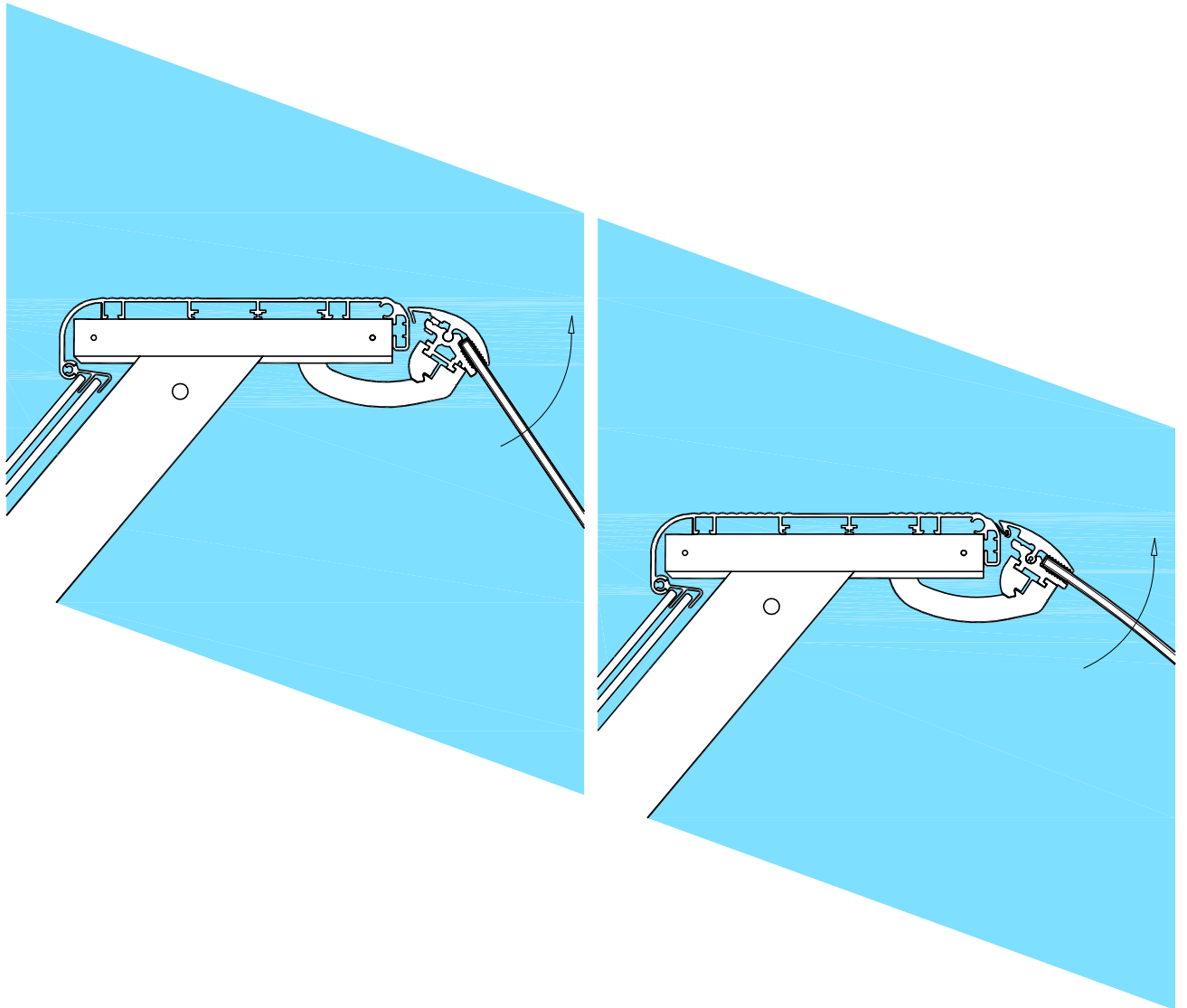

Sistema **020**  
System **020**

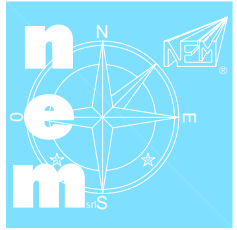
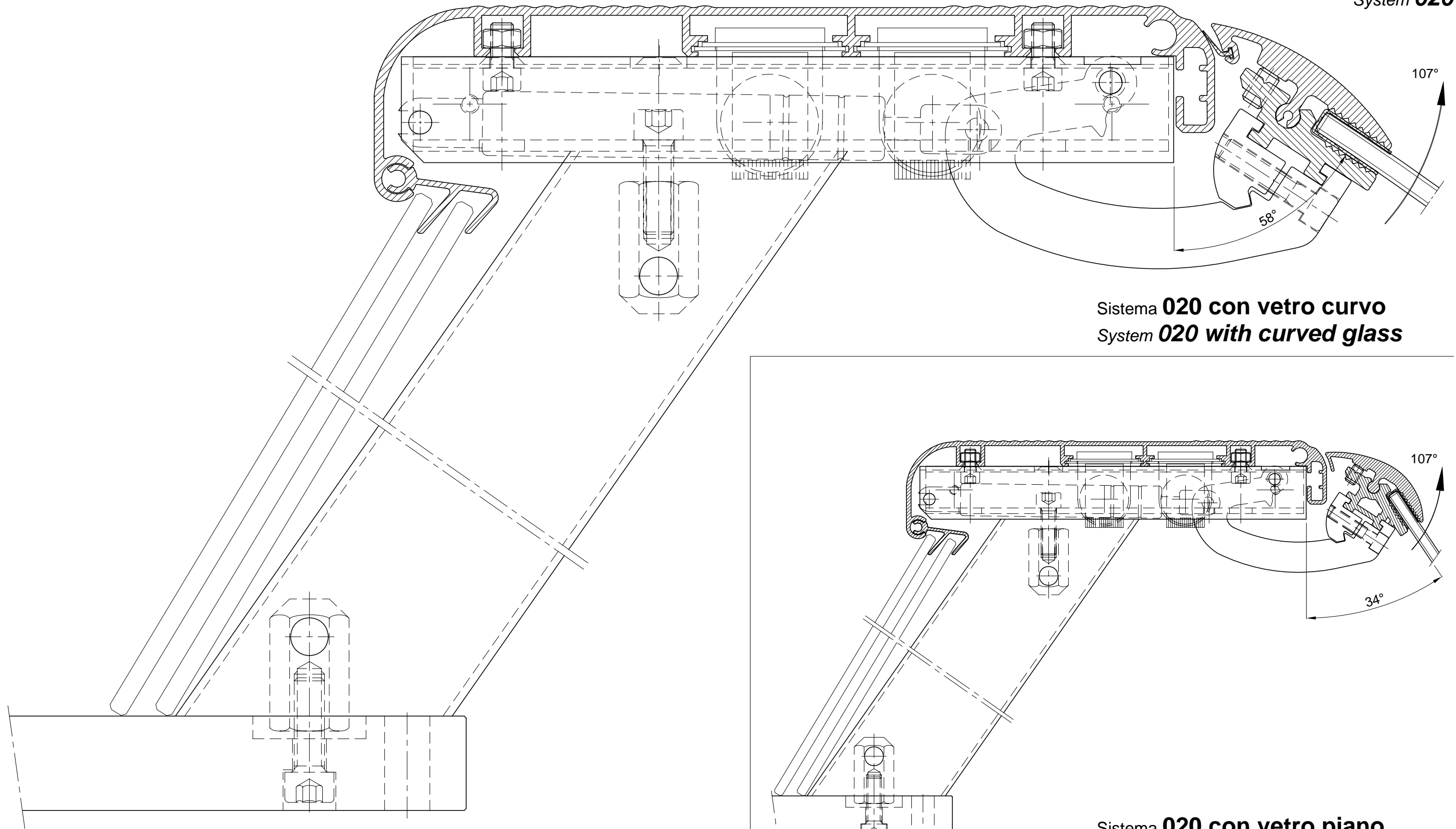

Sistema **020** con vetro curvo  
System **020** with curved glass

Sistema **020** con vetro piano  
System **020** with straight glass

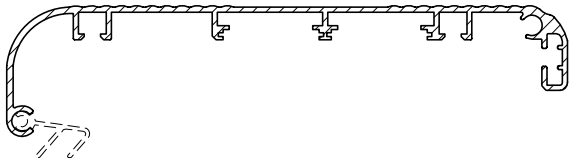

Profilo cappello  
*Top shelf profile*

L=5200mm **Cod. 020.1000**



Profilo scorrevoli  
*Sliding profile*

L=5200mm **Cod. 020.1300**

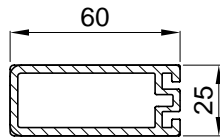

Profilo montante laterale  
*Lateral upright profile*

L=5000mm **Cod. 070.1350**

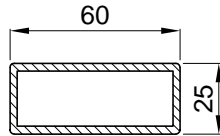

Profilo montante laterale  
*Lateral upright profile*

L=5000mm **Cod. 010.0007**

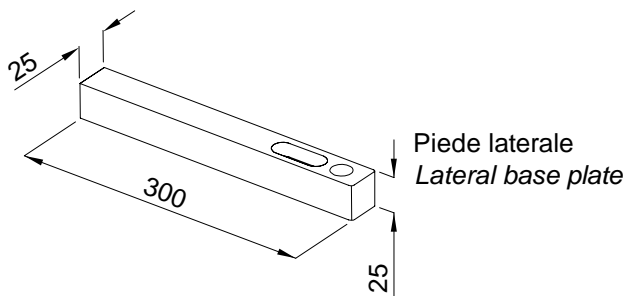

Piede laterale  
*Lateral base plate*

**Cod. 010.2310**

Maniglie e profili battuta maniglia opzionali  
*Optional hand grip and tilt base profiles*

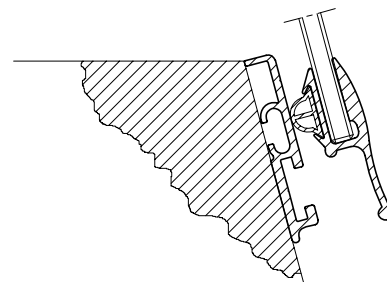
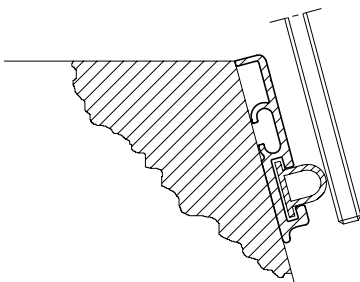

Vedi pag. 210/01 e 210/02  
*See sheet 210/01 e 210/02*

Pinza vetro curvo  
Curved glass clamp

58°

Vite STEI M6x12  
Screw STEI M6x12  
Cod. 002.0400.00

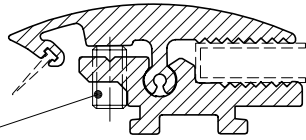

Profilo pinza completo  
Complete glass clamp profile

L=5200mm Cod. 040.1500

Pinza vetro dritto  
Straight glass clamp

34°

Vite STEI M6x12  
Screw STEI M6x12  
Cod. 002.0400.00

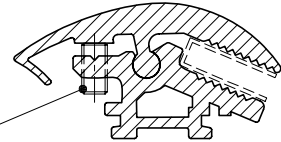

Profilo pinza completo  
Complete glass clamp profile

L=5200mm Cod. 041.1500

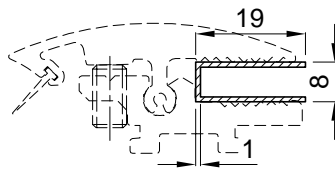

Guarnizione 19x8x1  
Gasket 19x8x1

L=100m Cod. 040.0099.00

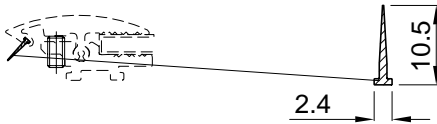

Guarnizione di chiusura  
Closing gasket

L=100m Cod. 550.0099.00

Dado esagonale M6  
Hexagon nut M6  
Cod. 002.2000.00

Spina Ø6x31.5  
Pin Ø6x31.5  
Cod. 005.2190.00

Vite TSPEI M6x12  
Screw TSPEI M6x12  
Cod. 002.0300.00

Spina pistone Ø6x17  
Gas spring pin Ø6x17  
Cod. 005.2192.00

Vite TCEI M6x35  
Screw TCEI M6x35  
Cod. 002.0115.00

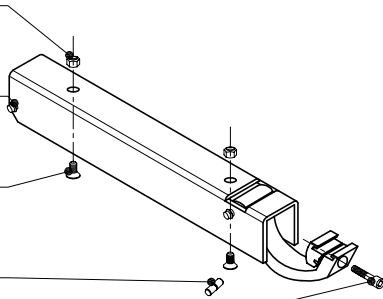

Scatola completa escluso pistone  
Complete case without gas spring

Cod. 020.1400

Dado esagonale M6  
Hexagon nut M6  
Cod. 002.2000.00

Vite TCEI M6x12  
Screw TCEI M6x12  
Cod. 002.0108.00

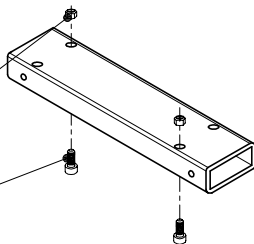

Piastra fissaggio montante compl. standard  
Complete upright fixing standard plate

Cod. 020.0114.00

Dado esagonale M6  
Hexagon nut M6  
Cod. 002.2000.00

Vite TCEI M6x12  
Screw TCEI M6x12  
Cod. 002.0108.00

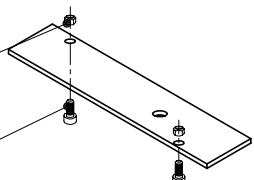

Piastra fissaggio montante compl. centr./neon  
Complete upright fixing central plate/neon

Cod. 020.0113.00

Vite TBEI M5x8  
Screw TBEI M5x8  
Cod. 002.0125.00

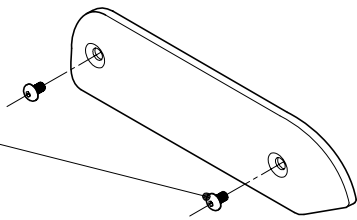

Tappo testata plastica con viti  
Complete end cap with screws

Dx/Rt  
Sx/Lt\*

Cod. 020.2012  
Cod. 020.2011

\* Rappresentato particolare Sx  
Left part represented

Vite STEI M4x6  
Screw STEI M4x6  
Cod. 002.0402.00

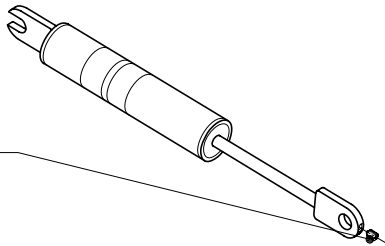

Molla a gas (vedi pag. 200/03)  
Gas spring (see sheet 200/03)

Mod. C. 56mm

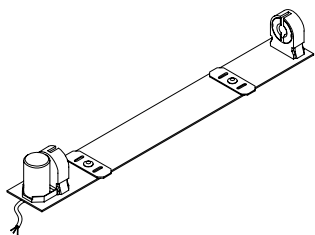

Cablaggio su lama mod. 050 - Neon da Ø26 (vedi pag. 225/01)  
Wiring on plate mod. 050 - Neon Ø26 (see sheet 225/01)

Vite TCEI M8x25  
Screw TCEI M8x25  
Cod. 002.0100.00

Tirante esagonale  
Hexagon tie rod  
Cod. 005.0100.00

Spina zigrinata Ø10x25  
Knurled pin Ø10x25  
Cod. 005.0102.00

Spina zigrinata Ø10x25  
Knurled pin Ø10x25  
Cod. 005.0102.00

Tirante esagonale  
Hexagon tie rod  
Cod. 005.0100.00

Vite TCEI M8x25  
Screw TCEI M8x25  
Cod. 002.0100.00

Tirante superiore  
Upper tie rod

Tirante inferiore  
Lower tie rod

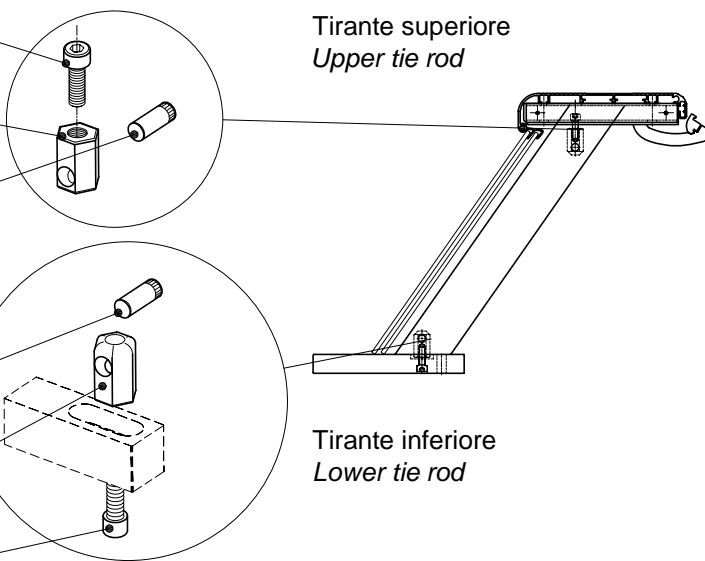

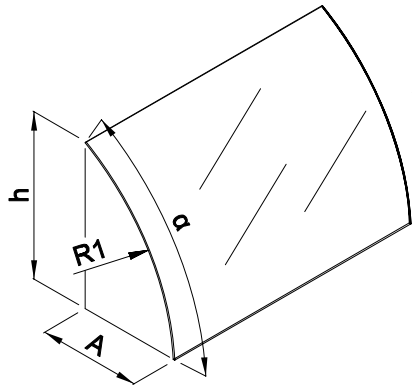

Vetri (vedi pag. 240/01 e seguenti)  
Glasses (see sheet 240/01 and next)

La NEM s.r.l. declina ogni responsabilità a civile e penale in caso di rotture dei vetri dovute a loro difetti o errato montaggio.

*NEM s.r.l. undertakes neither public nor criminal liability in case glasses crack due to their defects or to a wrong assembling.*

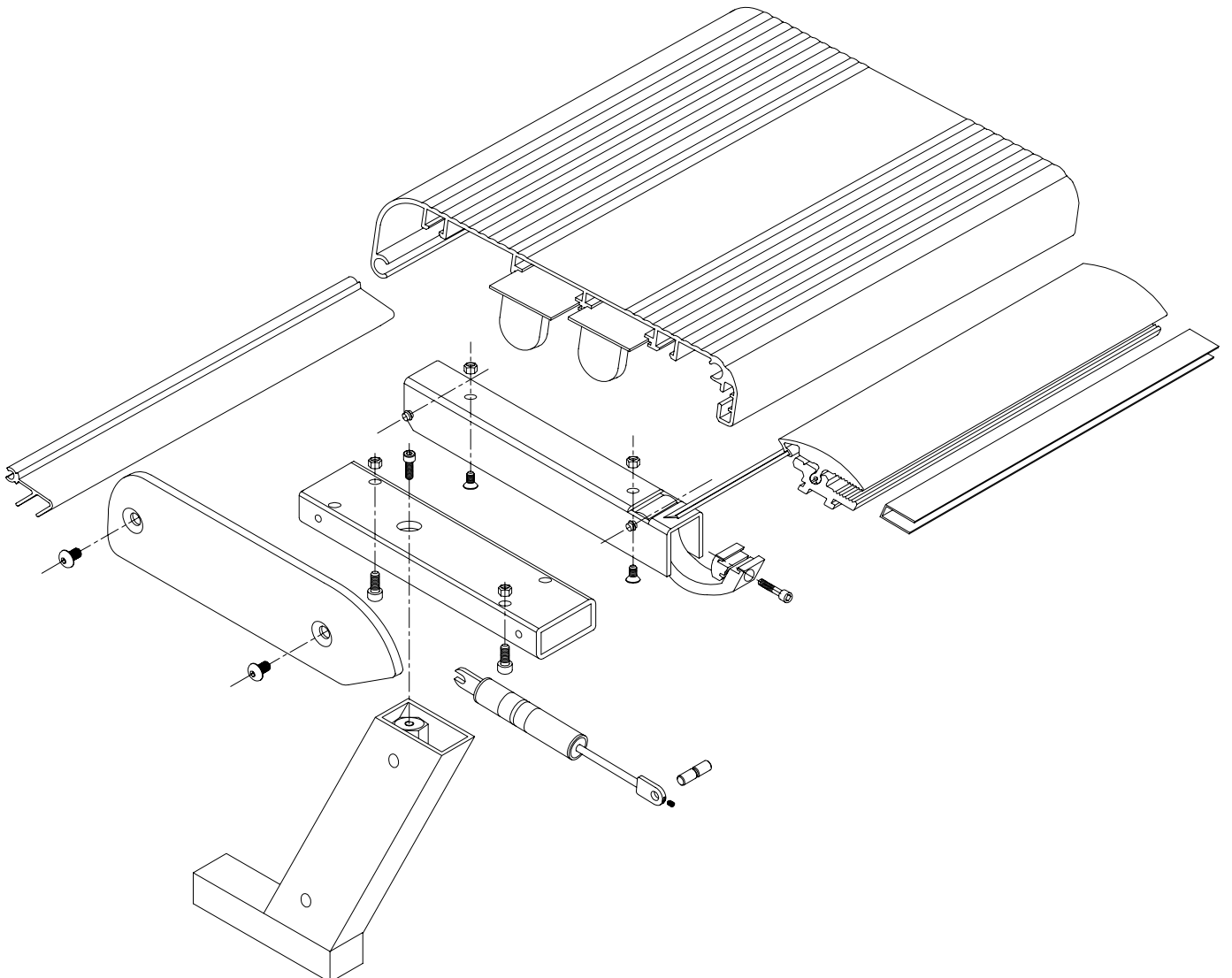
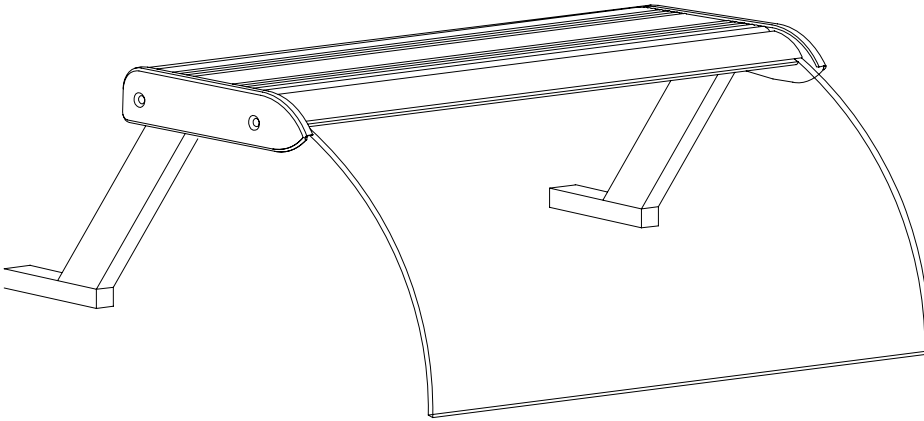

**Accessori per composizioni angoli**  
**Accessories for corners composition**

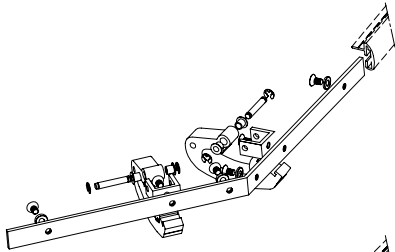

Assieme staffa di rinforzo per angoli aperti  
*Stiffening bracket assembly for open corners*

**Cod. 005.2180.00**

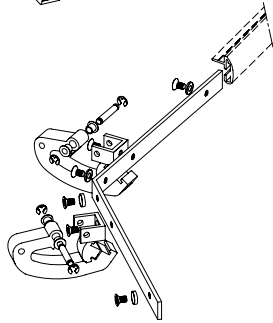

Assieme staffa di rinforzo per angoli chiusi  
*Stiffening bracket assembly for closed corners*

**Cod. 005.2181.00**

**Esempi di composizione per angoli**  
**Composition examples for corners**

Assieme staffa rinforzo AAP  
*Stiffening bracket for open corners*  
**Cod. 005.2180.00**

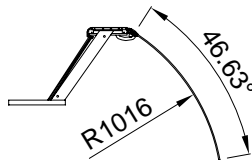

Assieme staffa rinforzo ACH  
*Stiffening bracket for closed corners*  
**Cod. 005.2181.00**

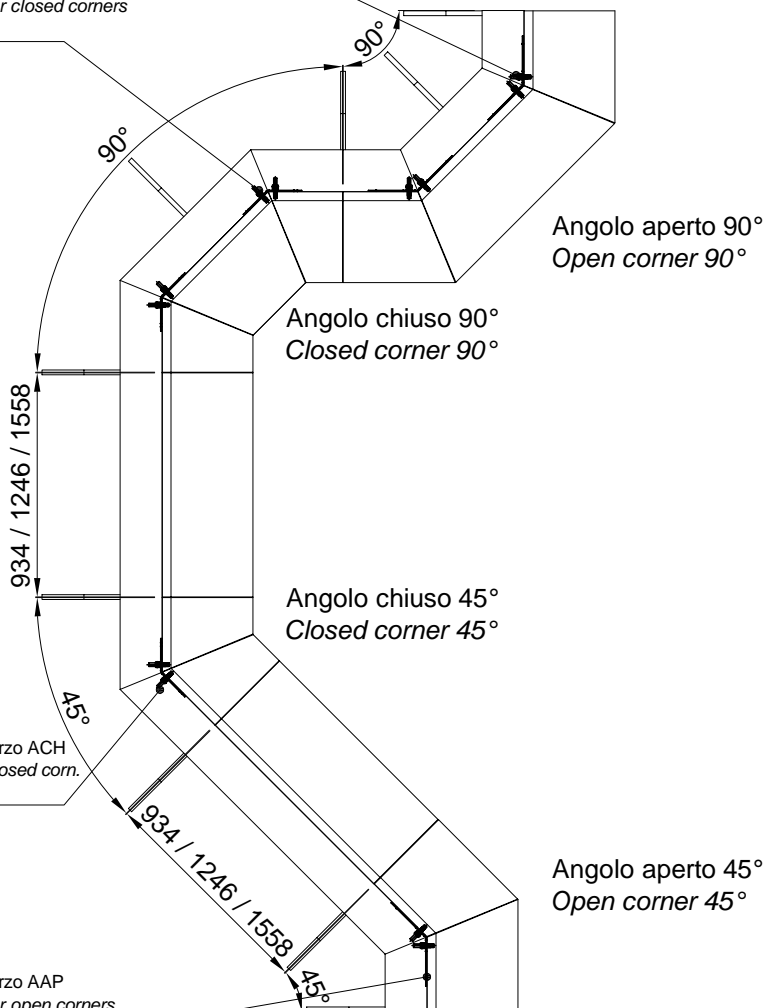

Assieme staffa rinforzo ACH  
*Stiffening bracket closed corn.*  
**Cod. 005.2181.00**

Assieme staffa rinforzo AAP  
*Stiffening bracket for open corners*  
**Cod. 005.2180.00**