

Apertura verso il basso per vetri lineari Sistema **070**
*Lift down opening for linear glasses System **070***

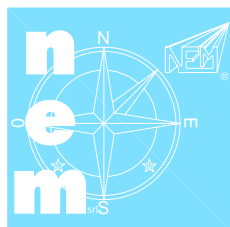

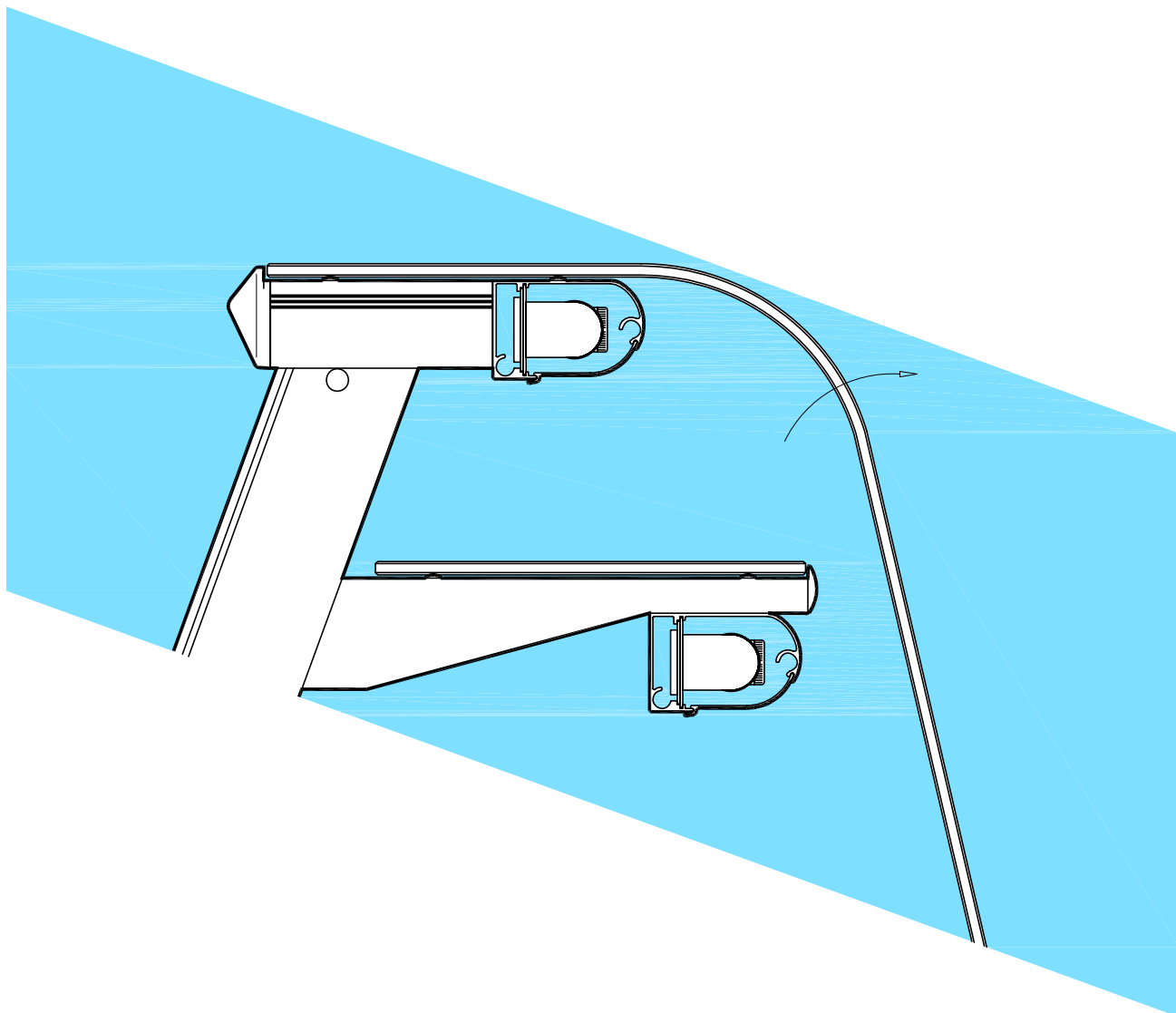

Sistema **070**
System **070**

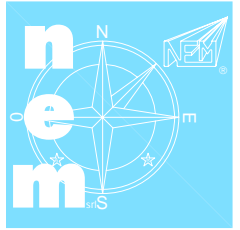
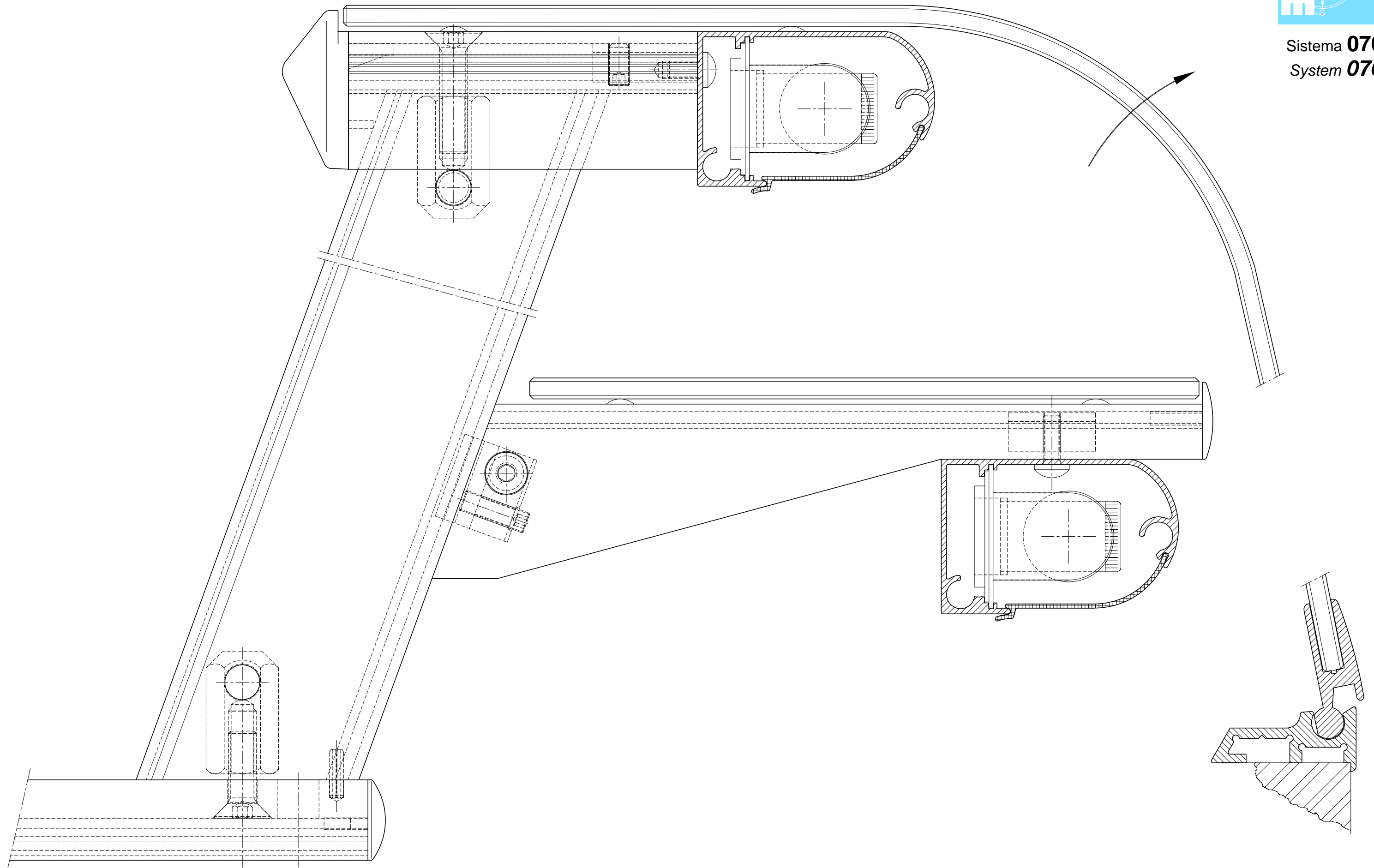

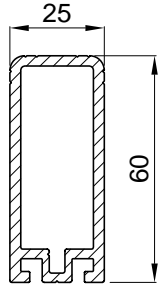

Profilo montante laterale
Lateral upright profile

L=5000mm **Cod. 070.1350**

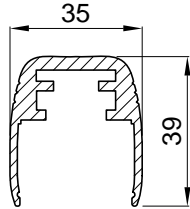

Profilo supporto
Support profile

L=5000mm **Cod. 073.2100**

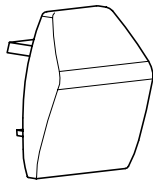

Tappo supporto in plastica
Plastic support plate end cap

Cod. 073.2120

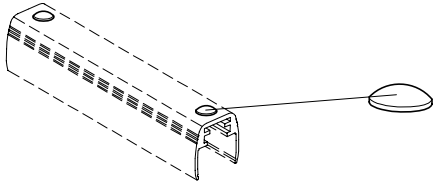

Poggia vetro Ø10mm
Glassrest Ø10mm

Cod. 006.1110.00

Vite TSPEI M8x35
Screw TSPEI M8x35
Cod. 002.0334.00

Spina zigrinata Ø10x25
Knurled pin Ø10x25
Cod. 005.0102.00

Tirante esagonale
Hexagon tie rod
Cod. 005.0100.00

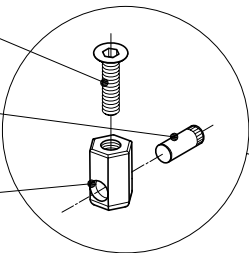

Tirante superiore
Upper tie rod

Spina zigrinata Ø10x25
Knurled pin Ø10x25
Cod. 005.0102.00

Tirante esagonale
Hexagon tie rod
Cod. 005.0100.00

Vite TSPEI M8x25
Screw TSPEI M8x25
Cod. 002.0309.00

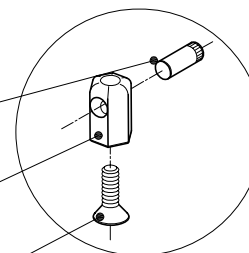

Tirante inferiore
Lower tie rod

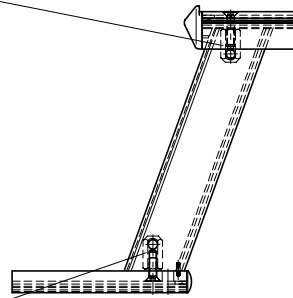

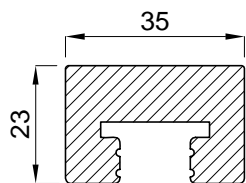

Profilo piede
Base plate profile

L=5000mm **Cod. 073.2300**

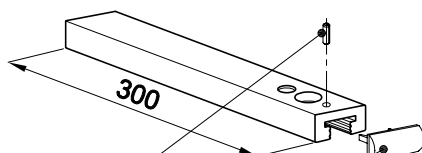

Spina elast. Ø4x14
Elastic pin Ø4x14
Cod. 002.2503.00

Piede standard completo
Complete standard base plate

Cod. 073.2312

Tappo piede in plastica
Plastic base plate end cap
Cod. 073.2350

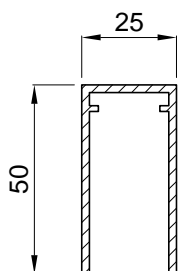

Profilo mensola intermedia
Intermediate shelf profile

L=5000mm **Cod. 070.1700**

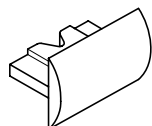

Tappo finale mensola in plastica
Plastic shelf end cap

Cod. 070.2352

Vite TSPEI M6x10
Screw TSPEI M6x10
Cod. 002.0305.00

Vite STEI M6x20
Screw STEI M6x20
Cod. 002.0414.00

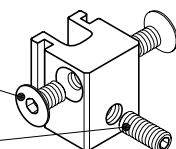

Blocchetto reggimensola completo di viti
Complete shelf block system with screws

Cod. 070.1875

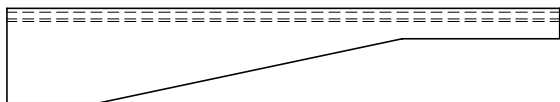

Mensole intermedie semifinite
Semifinished intermediate shelves

Vedi pag. 215/02
See sheet 215/02

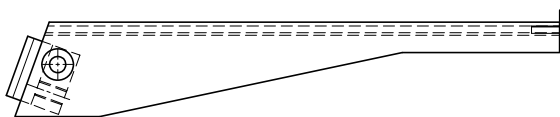

Mensole intermedie complete
Complete intermediate shelves

Vedi pag. 215/02
See sheet 215/02

Cod. 070.1501
Cod. 070.1511

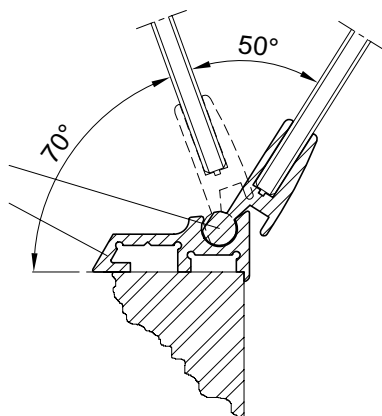

Profilo maniglia
Hand grip profile

L=5200mm **Cod. 070.1501**

Profilo base maniglia
Tilt base profile

L=5200mm **Cod. 070.1511**

Vedi pag. 210/02
See sheet 210/02

Vite TCEI M5x12
Screw TCEI M5x12
Cod. 002.0139.00

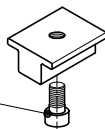

Blocchetto reggiplafoniera completo di vite
Complete light canopy block system

Cod. 070.1862.0G

Vite TBEI M5x8
Screw TBEI M5x8
Cod. 002.0125.00

Vite STEI M6x12
Screw STEI M6x12
Cod. 002.0400.00

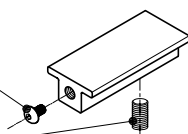

Blocchetto reggiplafoniera completo di viti 90°
Complete light canopy block system 90°

Cod. 050.0806.0G

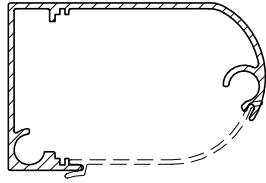

Profilo lampada
Light canopy profile

L=5200mm **Cod. 030.0800**

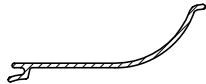

Profilo protezione lampada
Light canopy protection

L=5000mm **Cod. 030.0900.00**

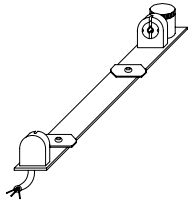

Cablaggio su lama mod. 050 - Neon da Ø26 (vedi pag. 225/01)
Wiring on plate mod. 050 - Neon Ø26 (see sheet 225/01)

Ranella in PVC
PVC washer
Cod. 005.0336.00

Pomello tappo lampada
Ball grip
Cod. 003.0345

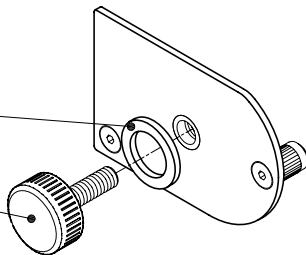

Tappo lampada con pomello
Light end cap with glass ball grip

Dx/Rt
Sx/Lt*

Cod. 030.1801
Cod. 030.1802

* Rappresentato particolare Sx
Left part represented

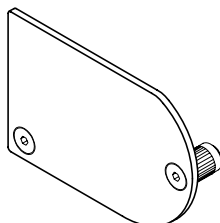

Tappo lampada senza pomello
Light end cap w/o glass ball grip

Dx/Rt
Sx/Lt*

Cod. 030.1803
Cod. 030.1804

* Rappresentato particolare Sx
Left part represented

