

Apertura a traslazione per banchine rendiresto Sistema **153**  
*Traverse opening for top shelves glasses System **153***

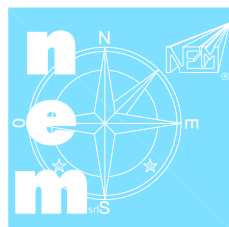

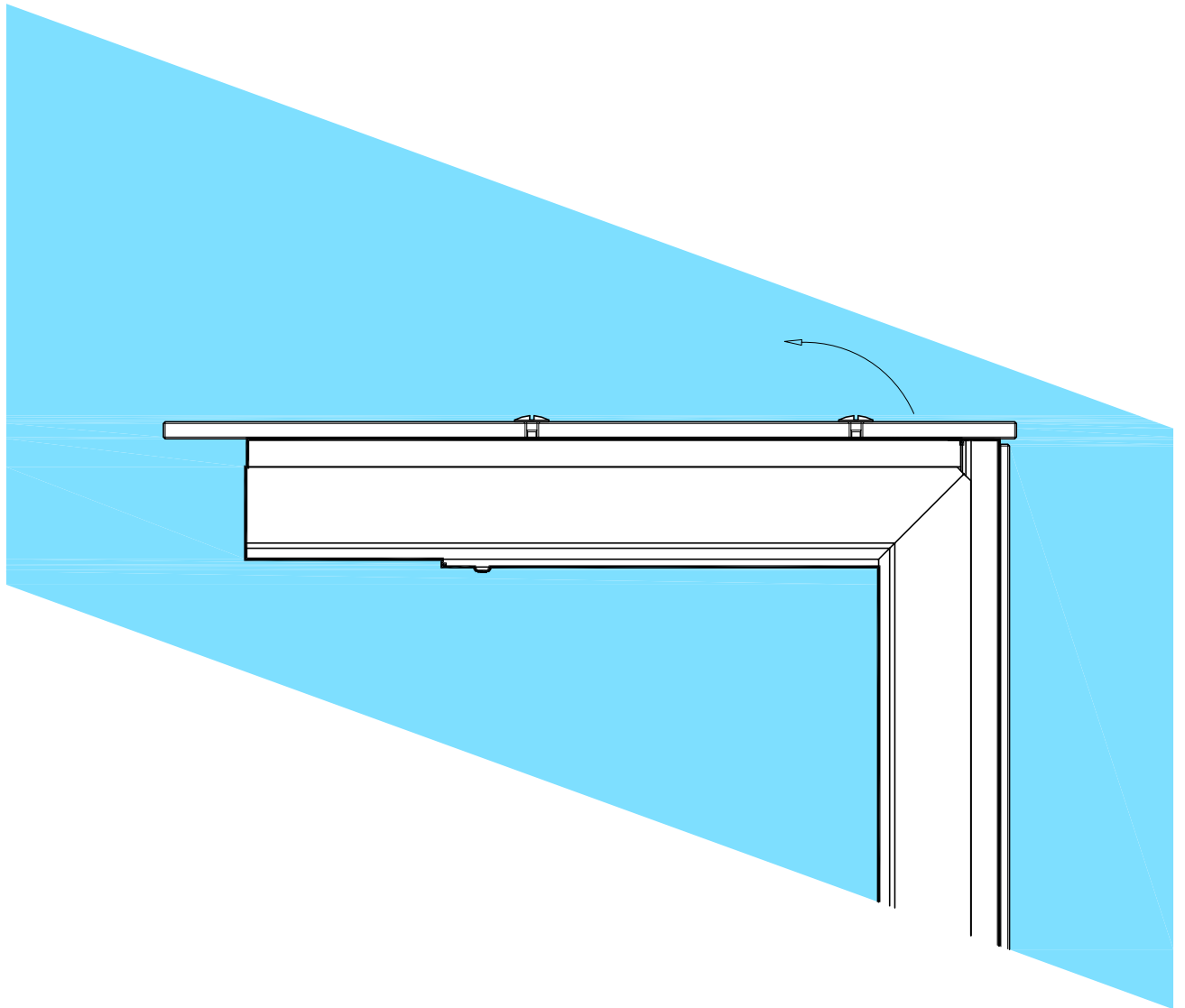

Sistema **153**  
System **153**

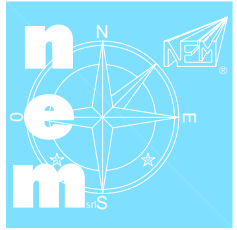
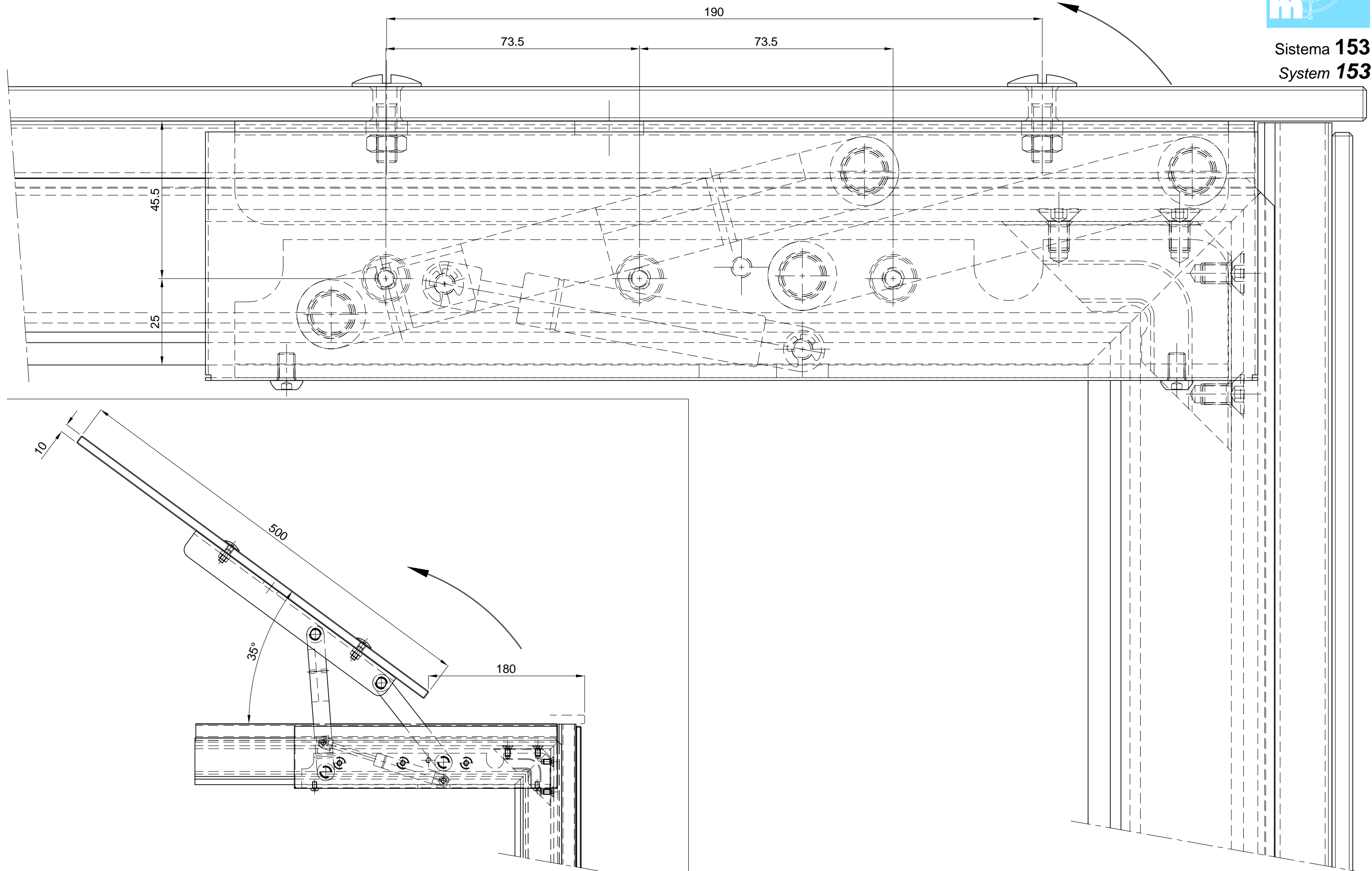

Anello di arresto radiale Ø5  
E-ring Ø5  
Cod. 002.2404.00

Spina pistone Ø6x21  
Gas spring pin Ø6x21  
Cod. 005.0135.00

Tappo copriscatola laterale  
Lateral case cover

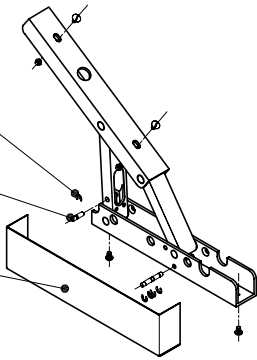

Scatola completa escl. pistone Dx/Rt  
Compl. later- case w/o gas spring Sx/Lt\*

Cod. 153.1400  
Cod. 153.1401

\* Rappresentato particolare Dx  
Right part represented

Vite TSPEI M6x14  
Screw TSPEI M6x14  
Cod. 002.0307.00

Ranella PVC  
PVC split washer  
Cod. 005.0332.00

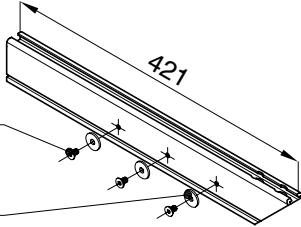

Supporto scatola completo  
Complete support case

Cod. 064.0018

Supporto scatola completo  
Complete case support

Vite TSPEI M6x12  
Screw TSPEI M6x12  
Cod. 002.0300.00

Montante  
Upright

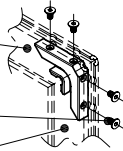

Kit minuteria fissaggio supporto al montante  
Kit small parts for fixing support case to upright

Cod. 001.0525.00

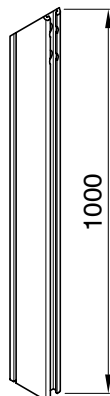

Montante semilavorato H=1000  
Semifinished upright H=1000

Cod. 064.0020

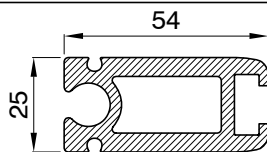

Profilo montante  
Upright profile

L=5000mm Cod. 064.0007

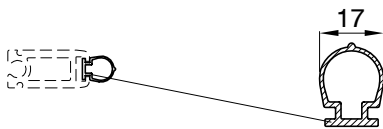

Guarnizione di chiusura vetro  
Glass seal gasket

L=1150mm Cod. 064.0399.00



Guarnizione di chiusura laterale  
Lateral seal gasket

L=50m Cod. 082.0299.00



Guarnizione di chiusura poster.  
Back side seal gasket

L=100m Cod. 066.0399.00

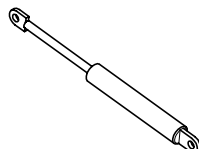

Molla a gas per linea (vedi pag. 200/03)  
Gas spring for linear case (see sheet 200/03)

Mod. C. 40mm